

3M™ Four-Wall Header

.100" × .100" Latch/Ejector, Straight and Right Angle

D3000 Series



- Military (with 3M's 3518 & N3518 polarizing key) and centerbump polarization
- Optional ejector latches
- Mounting holes for securing header to board
- Optional polarizing posts available
- High temperature insulator suitable for "no lead" soldering operations
- High temperature insulator in through-hole version suitable for "paste in hole" reflow soldering
- RoHS Compliant. See the Regulatory Information Appendix (RIA) in the "RoHS compliance" section of www.3Mconnectors.com for compliance information (RIA E1 and C1 apply)

Date Modified: May 21, 2012

TS-2245-F
Sheet 1 of 4

Physical

Insulator:

Material: High Temp Glass Filled Polyester (PCT)

Flammability: UL 94V-0

Color: Black (PCT)

Contact:

Material: Brass

Plating:

Underplating: 50 -150 μ " [1.25 μ m] Ni

Wiping Area: 15 μ " [0.381 μ m] Gold

Solder Tails: 40 - 120 μ " [1-3 μ m] Matte Tin

Marking: 3M Logo, Part Identification Number and Orientation Triangle

Electrical

Current Rating: 5.00 A, 1 Contact Powered

3.00 A, 6 Contacts Powered

1.75 A, All Contacts Powered

Rating Conditions: EIA-364-070 Method 2, 30°C maximum temperature rise, 20% derated. Reference appropriate 3M Product Specification for detailed current derating curves.

Insulation Resistance: $>1 \times 10^9 \Omega$ at 500 V_{DC}

Withstanding Voltage: 1,000 V_{RMS} at Sea Level

Environmental

Temperature Rating: -55°C to +105°C

Process Rating: 260°C, profile per J-STD-020C, single pass

Moisture Sensitivity Level: 1 (per J-STD-020C)

UL File No.: E68080

3M

Electronic Solutions Division
Interconnect Solutions
<http://www.3Mconnectors.com>

3M is a trademark of 3M Company.
For technical, sales or ordering information call
800-225-5373

3M™ Four-Wall Header

.100" × .100" Latch/Ejector, Straight and Right Angle

D3000 Series

Pin Qty	3M Part Number	Dimensions				Polarizing Notches
		A	B	C	D	
06	3869	1.065 (27.05)	0.905 (22.99)	0.665 (16.89)	0.505 (12.83)	B*
08	3889	1.165 (29.59)	1.005 (25.53)	0.765 (19.43)	0.605 (15.37)	B*
10	3793	1.265 (32.13)	1.105 (28.04)	0.865 (21.97)	0.705 (17.91)	BC
14	3314	1.465 (37.21)	1.305 (33.12)	1.065 (27.05)	0.905 (22.99)	BC
16	3408	1.565 (39.75)	1.405 (35.66)	1.165 (29.59)	1.005 (25.53)	ABC
20	3428	1.765 (44.83)	1.605 (40.74)	1.365 (34.67)	1.205 (30.61)	ABC
24	3627	1.965 (49.91)	1.805 (45.82)	1.565 (39.75)	1.405 (35.69)	ABC
26	3429	2.065 (52.45)	1.905 (48.36)	1.665 (42.29)	1.505 (38.23)	ABC
30	3440	2.265 (57.53)	2.105 (53.44)	1.865 (47.37)	1.705 (43.31)	ABC
34	3431	2.465 (62.61)	2.305 (58.52)	2.065 (52.45)	1.905 (48.39)	ABC
40	3432	2.765 (70.23)	2.605 (66.14)	2.365 (60.07)	2.205 (56.01)	ABC
50	3433	3.265 (82.93)	3.105 (78.84)	2.865 (72.77)	2.705 (68.71)	ABC
60	3372	3.765 (95.63)	3.605 (91.54)	3.365 (85.47)	3.205 (81.41)	ABC
64	3764	3.965 (100.71)	3.805 (96.62)	3.565 (90.55)	3.405 (86.49)	ABC

Inch
(mm)

Tolerance Unless Noted		
	.0	.00
	.00	.000
	±.1	±.01 ±.005

[] Dimensions for Reference only

* Available without center notch B. Contact 3M.

3M Part Number Suffix	Contact Tail	Dim E	Pin Cross Section			Dimension G
			Dim F	Diagonals	Corner Radii	
-5XX2	Solder Tail for .062 [1.57] Thick PC Board	.112 ± .010 [2.84]	.0245 ± .0005 [0.622]	.028 ± .001 [0.71]	.0075 Ref [0.191]	Ø.035 ± .003 [0.89] (See Note 3)
-6XX2						

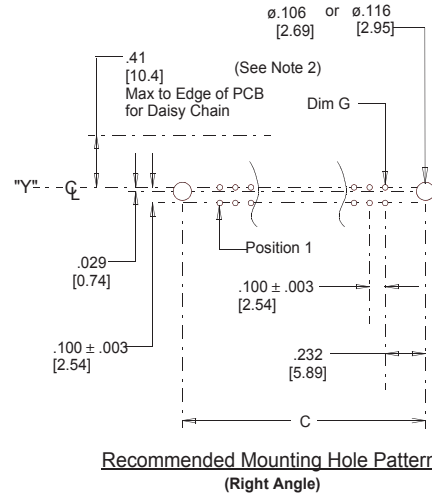
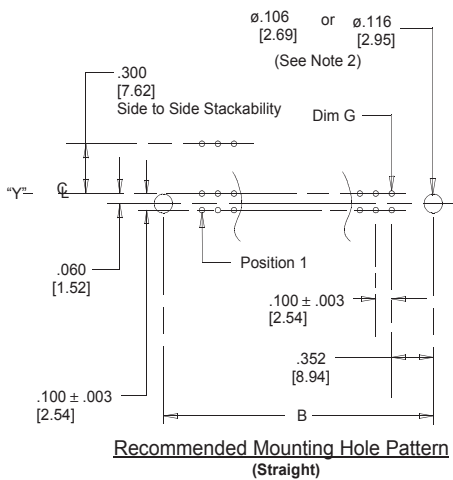

Notes:

- Notches A & C will accommodate 3M Polarizing Keys (3M Part #3518 or #N3518).
- Mounting hardware: From solder side of pc board use #4-24 thread cutting screw (3M Part # 3341-5) and .116 [2.95] dia mounting hole. For right angle version only, #2-56 bolt and nut (3M Part # 3341-6) with .106 [2.69] dia mounting hole may be used. See illustrations on page 4.
- Contact your 3M sales representative for custom requirements.

Ordering Information

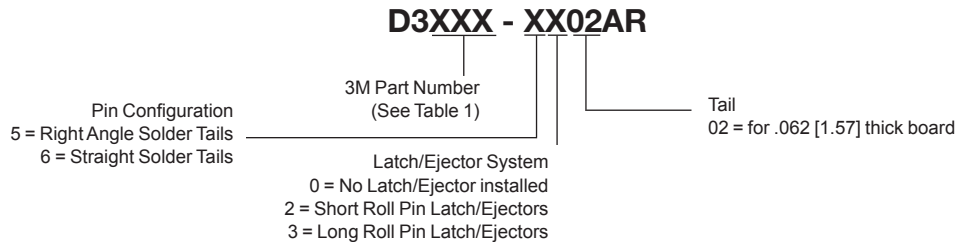

TS-2245-F
Sheet 3 of 4

3M™ Four-Wall Header

.100" × .100" Latch/Ejector, Straight and Right Angle, Accessories

D3000 Series

Part Customization

This spec sheet details our standard offering.

3M has several capabilities that can provide a part tailored to your specific needs. Ask your 3M sales representative or customer service for more details.

- The -2 & -3 roll pin latches (may be ordered separately with roll pins included)
- Snap-in style latch/ejectors in either short (N3XXXX5XXX) or long (N3XXX-X6XX) styles, may also be ordered separately, and are functional and dimensional equivalents to the -2 and -3 roll pin latches.

If ordering latches separately, please use the below chart

	Short Latch	Long Latch	Latch Style	Color
High Temperature (PPA)	N3505-30B	N3505-31B	Snap In	Black
High Temperature (PCT)	N3505-2B	N3505-3B	Roll Pin	Black

- Selective pin removal (ATA or other compatibility)

Polarizing Post



Note: Insert Post into one mounting hardware hole on bottom of header. Set post to protrude .115" [2.92]

Polarizing Keys

N3518	LCP	Black	.02
-------	-----	-------	-----



Note: #2216 B/A Scotchweld can be used to adhere keys.

Mounting Hardware



TS-2245-F
Sheet 4 of 4



Electronic Solutions Division
Interconnect Solutions
<http://www.3Mconnectors.com>

3M is a trademark of 3M Company.
For technical, sales or ordering information call
800-225-5373

3M is a trademark of 3M Company.

Important Notice

All statements, technical information, and recommendations related to 3M's products are based on information believed to be reliable, but the accuracy or completeness is not guaranteed. Before using this product, you must evaluate it and determine if it is suitable for your intended application. You assume all risks and liability associated with such use. Any statements related to the product which are not contained in 3M's current publications, or any contrary statements contained on your purchase order shall have no force or effect unless expressly agreed upon, in writing, by an authorized officer of 3M.

Warranty; Limited Remedy; Limited Liability.

This product will be free from defects in material and manufacture for a period of one (1) year from the time of purchase. **3M MAKES NO OTHER WARRANTIES INCLUDING, BUT NOT LIMITED TO, ANY IMPLIED WARRANTY OF MERCHANTABILITY OR FITNESS FOR A PARTICULAR PURPOSE.** If this product is defective within the warranty period stated above, your exclusive remedy shall be, at 3M's option, to replace or repair the 3M product or refund the purchase price of the 3M product. **Except where prohibited by law, 3M will not be liable for any indirect, special, incidental or consequential loss or damage arising from this 3M product, regardless of the legal theory asserted.**



3M Electronics Solutions Division

6801 River Place Blvd.
Austin, TX 78726-9000
U.S.A.
1-800-225-5373
www.3Mconnectors.com

Please recycle. Printed in USA.
© 3M 2012. All rights reserved.
RIA-2217B-E