



Grayhill, Inc.

## 62S11-L5-030S

Onderdeel nummer:

62S11-L5-030S

Vervaardiger / Brand:

Grayhill, Inc.

Produk Beskrywing

ROTARY ENCODER OPTICAL 32PPR

Inligtingsblaaie:

 62S11-L5-030S.pdf

RoHS Status

 Loodvry / RoHS voldoen

Voorraadvoorwaarde

2248 pcs stock

Stuur Van

Hong Kong

Verskeping manier

DHL/Fedex/TNT/UPS/EMS

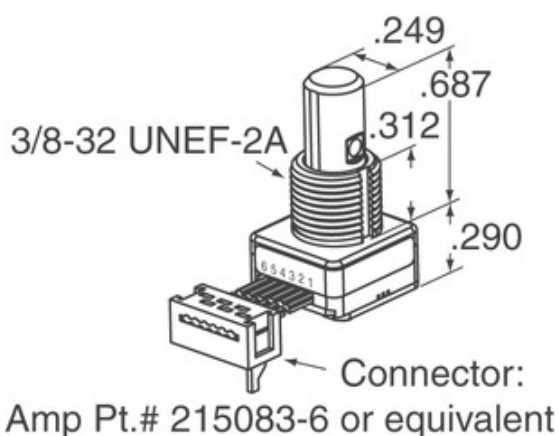

Beeld kan voorstelling wees. Sien spesifikasies vir produkinligting.







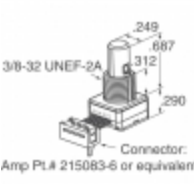

## Spesifikasies van 62S11-L5-030S

ONDERDEEL NOMMER	62S11-L5-030S
VERVAARDIGER	Grayhill, Inc.
BESKRYWING	ROTARY ENCODER OPTICAL 32PPR
LEI VRYE STATUS / ROHS STATUS	Loodvry / RoHS voldoen
HOEVEELHEID BESKIKBAAR	2248 pcs
DATABLAD	 62S11-L5-030S.pdf
SPANNING - VOORSIENING	5V
BEËINDIGINGSTYL	Cable Leads
REEKS	62S
ROTASIE LEWE (CYCLES MIN)	1M
PULSE PER REWOLUSIE	32
UITGAWE TIPE	Quadrature (Incremental)
ANDER NAME	62S11L5030S
GEAARDHEID	Vertical
MOUNTING TYPE	Panel Mount
VOGGEVOELIGHEIDSVLAK (MSL)	1 (Unlimited)
LEI VRYE STATUS / ROHS STATUS	Lead free / RoHS Compliant
ENCODER TYPE	Optical
DETENT	Yes
INGEBOUDE SKAKELAAR	Yes
AKTUATOR TYPE	1/4" Dia Flatted End

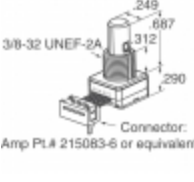
## Verwante Tags

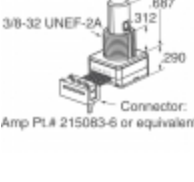
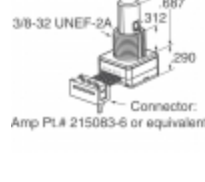
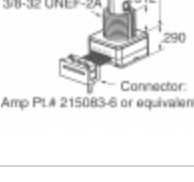
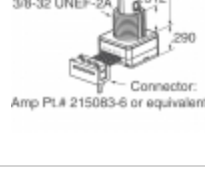
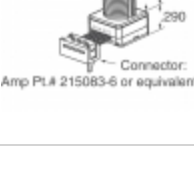
Grayhill, Inc. 62S11-L5-030S	62S11-L5-030S Verspreider	62S11-L5-030S Verskaffer
62S11-L5-030S prys	62S11-L5-030S Prente	62S11-L5-030S Image
62S11-L5-030S PDF Datablad	62S11-L5-030S Download Data Heet	62S11-L5-030S-datablad
62S11-L5-030S Voorraad	Koop 62S11-L5-030S	Koop Grayhill, Inc. 62S11-L5-030S
Grayhill, Inc. 62S11-L5-030S	Grayhill, Inc. Verskaffer	Grayhill, Inc. Verspreider
Grayhill, Inc. 62S11-L5-030S	Grayhill Inc. 62S11-L5-030S	

## Verwante Produkte

 <p><b>62S11-L4-080CH</b> vervaardigers: Grayhill, Inc. beskrywing: ROTARY ENCODER OPTICAL 32PPR Op voorraad: 1886 pcs</p> <p><b>RFQ</b></p>	 <p><b>62S11-L5-PH</b> vervaardigers: Grayhill, Inc. beskrywing: ROTARY ENCODER OPTICAL 32PPR Op voorraad: 2218 pcs</p> <p><b>RFQ</b></p>
 <p><b>62S11-L5-035C</b> vervaardigers: Grayhill, Inc. beskrywing: ROTARY ENCODER OPTICAL 32PPR Op voorraad: 1861 pcs</p> <p><b>RFQ</b></p>	 <p><b>62S11-L5-P</b> vervaardigers: Grayhill, Inc. beskrywing: ROTARY ENCODER OPTICAL 32PPR Op voorraad: 2265 pcs</p> <p><b>RFQ</b></p>
 <p><b>62S11-L5-060C</b> vervaardigers: Grayhill, Inc. beskrywing: ROTARY ENCODER OPTICAL 32PPR Op voorraad: 2163 pcs</p> <p><b>RFQ</b></p>	 <p><b>62S11-L4-080SH</b> vervaardigers: Grayhill, Inc. beskrywing: ROTARY ENCODER OPTICAL 32PPR Op voorraad: 1886 pcs</p> <p><b>RFQ</b></p>
 <p><b>62S11-L5-040C</b> vervaardigers: Grayhill, Inc. beskrywing: ROTARY ENCODER OPTICAL 32PPR Op voorraad: 1990 pcs</p> <p><b>RFQ</b></p>	 <p><b>62S11-L5-050CH</b> vervaardigers: Grayhill, Inc. beskrywing: ROTARY ENCODER OPTICAL 32PPR Op voorraad: 2186 pcs</p> <p><b>RFQ</b></p>
 <p><b>62S11-L4-PH</b> vervaardigers: Grayhill, Inc. beskrywing: ROTARY ENCODER OPTICAL 32PPR Op voorraad: 2261 pcs</p> <p><b>RFQ</b></p>	 <p><b>62S11-L5-020CH</b> vervaardigers: Grayhill, Inc. beskrywing: ROTARY ENCODER OPTICAL 32PPR Op voorraad: 1861 pcs</p> <p><b>RFQ</b></p>
 <p><b>62S11-L4-P</b> vervaardigers: Grayhill, Inc. beskrywing: ROTARY ENCODER OPTICAL 32PPR Op voorraad: 2037 pcs</p> <p><b>RFQ</b></p>	 <p><b>62S11-L5-020C</b> vervaardigers: Grayhill, Inc. beskrywing: ROTARY ENCODER OPTICAL 32PPR Op voorraad: 2095 pcs</p> <p><b>RFQ</b></p>

Kopiereg © 2020 Betroubare verspreider van elektroniese komponente

E-pos: Info@infinity-electronic.com

Adres: 17F, Gaylord Commercial Building, 114-118 Lockhart Road, Wan Chai, Hong Kong

